



# Discretisation of continuous-time dynamic multi-input multi-output systems with non-uniform delays

Z.M. Kassas

Radionavigational Laboratory, Wireless Networking & Communications Group, Department of Electrical and Computer Engineering, The University of Texas at Austin, USA  
 E-mail: zkassas@ieee.org

**Abstract:** Input and output time delays in continuous-time (CT) dynamic systems impact such systems differently as their effects are encountered before and after the state dynamics. Given a fixed sampling time, input and output signals in multiple-input multiple-output (MIMO) systems may exhibit any combination of the following four cases: no delays, integer-multiple delays, fractional delays and integer-multiple plus fractional delays. A common pitfall in the digital control of delayed systems literature is to only consider the system timing diagram to derive the discrete-time (DT) equivalent model; hence, effectively ‘lump’ the delays across the system as one total delay. DT equivalent models for systems with input delays are radically different than those with output delays. Existing discretisation techniques for delayed systems usually consider the delays to be integer-multiples of the sampling time. This study is intended to serve as a reference for systematically deriving DT equivalent models of MIMO systems exhibiting any combination of the four delay cases. This algorithm is applied towards discretising an MIMO heat exchanger process with non-uniform input and output delays. A significant improvement towards the CT response was noted when applying this algorithm as opposed to rounding the delays to the closest integer-multiple of the sampling time.

## 1 Introduction

Time delays are inevitable in many systems, such as aerospace, chemical, digital, networked control and manufacturing. Time delays may appear in the system states, control inputs or measurements [1]. In aerospace systems, if the spacecraft is controlled from the Earth, measurements and command signals travel back and forth with non-negligible time delays [2]. In chemical processes, time delays arise due to piping between different units. In certain digital systems, computational delays are non-negligible and must be compensated for [3]. In networked control systems, where the plants, sensors, controllers and actuators reside on different nodes, time delays may arise because of signal routing within the network [4–6]. In manufacturing facilities, time delays commonly affect measured variables. Process instrumentation like thermocouples, gauges, compensators and converters do not respond instantaneously to signal changes. Manipulated variables are also delayed from the moment the signals are computed to the time they impact the process. Such delays may play a detrimental role in process control [7].

The control of systems with time delays is generally difficult in theory and practice [8–12]. Time delays often put severe restrictions on achievable feedback performance [13–15]. Delayed continuous-time (CT) linear systems are infinite-dimensional. The discrete-time (DT) equivalent system is, however, finite-dimensional [16]. This order reduction makes the discretisation of delayed systems not

only desirable from a digital implementation perspective, but also from a simplified analysis and synthesis perspective as well. However, such a desirable dimensional reduction may increase the model mismatch between the delayed CT system and its DT equivalent. Robustness of delayed and perturbed sampled-data systems under digital redesign has received the attention of many studies [17, 18].

Discretisation techniques for delayed CT systems can be found in the literature [19–21]. However, these techniques often assume the time delay to be an integer-multiple of the sampling time. Some approximations have been proposed for systems with delays that are non-integer multiples of the sampling time, that is, systems with fractional delays. Among them are to round the delays to the closest integer-multiple of the sampling time, the use of Taylor-series expansions and the use of the Runge–Kutta (RK) method involving polynomial interpolations [22–24]. Nevertheless, these approximations introduce model mismatches, which prevent the DT model response from reaching the actual CT response at the sampling instants.

Transfer functions (TFs) of systems with fractional time delays have been thoroughly analysed through the modified  $z$ -transform [25, 26]. TFs characterise the input–output behaviour of a system, while the state information is suppressed. Single-input single-output (SISO) CT TFs with time delay(s) have the structure  $G(s) = e^{-\lambda s} H(s)$ , where  $H(s)$  is the delay-free TF and  $\lambda$  is the time delay. This structure shows that the DT equivalent TF,  $G(z)$ , will be the same regardless if such delay(s) correspond to the input or

the output signal [19]. This is not the case, however, for delayed state-space (SS) models. SS models with fractional time delays have not been analysed to the same extent as TFs. State variables often have physical interpretations; hence, it is desirable to obtain a DT equivalent SS representation. Discretisation of SISO linear time-invariant (LTI) systems with only a fractional input delay has been considered in [19, 20, 27]. Additionally, discretisation of systems with ‘inner’ time delays has been considered in [16, 28], whereas discretisation of systems with internal and input delays via finite-impulse response (FIR) filtering approximation has been addressed in [29].

In [30], an algorithm for discretising CT multiple-input multiple-output (MIMO) LTI systems with non-uniform input and/or output fractional time delays was presented. However, that algorithm assumed that all input and/or output signals were delayed by fractional values. This is a bit restrictive, since given an arbitrary CT MIMO system and a fixed sampling time,  $T$ , input and output channels may exhibit any combination of the following cases: no delays, integer-multiple delays, fractional delays and integer-multiple plus fractional delays. This paper extends the algorithm of [30] to the general case of discretising CT MIMO LTI systems, where input and/or output signals exhibit any combination of the four delay cases. Particularly, this algorithm will handle the  $2^8$  different cases an MIMO system may experience.

Input and output time delays impact SS models differently as their effects are encountered before and after the state dynamics. As such, discretisation of systems with such delays must compensate for these delays by considering their separate and combined effects on the system states and outputs. Unfortunately, in digital control of delayed systems literature, some authors do not pay attention to such fact, and they commit the common pitfall of considering only the system timing diagram to derive the DT equivalent model. So, they effectively ‘lump’ the delay across the system as one ‘total’ delay (e.g. see [31, 32]). As will be discussed in this paper, DT equivalent models for systems with input delays are radically different than those with output delays. This paper is intended to serve as a reference for systematically deriving DT equivalent models of MIMO systems exhibiting any combination of input and output delays. In particular, this paper considers the system in Fig. 1, which depicts a delayed CT MIMO LTI system ( $\mathbf{A}$ ,  $\mathbf{B}$ ,  $\mathbf{C}$ ,  $\mathbf{D}$ ) in the prototypical sampled-data system configuration, where the delayed inputs and outputs of the CT system are interfaced through a digital to analogue (D/A) converter via zero-order hold (ZOH) and an analogue to digital (A/D) converter via periodic sampling, respectively. The objective is to find the DT equivalent system, ( $\mathbf{A}_d$ ,  $\mathbf{B}_d$ ,  $\mathbf{C}_d$ ,  $\mathbf{D}_d$ ), such that the two systems are equivalent, and the

response from the DT system matches that of its CT counterpart at the sampling instants.

This paper is organised as follows. Section 2 derives the algorithms for discretising delayed CT systems by considering the cases of input, output and simultaneous input and output delays. Section 3 presents the application of the proposed discretisation algorithm to a particular example. Concluding remarks are discussed in Section 4.

## 2 Discretisation algorithms for systems with input and output time delays

This section derives algorithms for discretising CT LTI systems with input and/or output time delays. The discretisation algorithms assume ZOH of the input signal, which implies that the input signal takes piecewise constant values within  $T$ , that is,  $\{\mathbf{u}(t) = \mathbf{u}(kT), kT \leq t < (k+1)T\}$ . The input signals,  $\mathbf{u}(t) \in \mathbb{R}^r$ , are assumed to be delayed by  $\boldsymbol{\theta} \in \mathbb{R}_+^r$ , whereas the output signals,  $\mathbf{y}(t) \in \mathbb{R}^m$ , are assumed to be delayed by  $\boldsymbol{\phi} \in \mathbb{R}_+^m$ . Without loss of generality, the input (output) signals will be assumed to be ordered such that the first  $R_1$  inputs ( $M_1$  outputs) are non-delayed; the second  $R_2$  inputs ( $M_2$  outputs) are delayed by integer-multiples of the sampling time; the third  $R_3$  inputs ( $M_3$  outputs) are delayed by fractions of the sampling time and the fourth  $R_4$  inputs ( $M_4$  outputs) are delayed by integer-multiples plus fractions of the sampling time. A signal with non-uniform delay  $\mathbf{s}(t - \boldsymbol{\vartheta}) \in \mathbb{R}^p$  will be interpreted as  $\mathbf{s}(t - \boldsymbol{\vartheta}) \triangleq [s_1(t - \vartheta_1) s_2(t - \vartheta_2) \dots s_p(t - \vartheta_p)]^T$ . In this paper, the following notation is adopted. Given a matrix  $\mathbf{P}$ , the vector  $\mathbf{p}_j$  is the  $j$ th column vector in  $\mathbf{P}$ , the vector  $\mathbf{p}_i^T$  as the  $i$ th row vector in  $\mathbf{P}$ , and the scalar  $p_{i,j}$  as the  $(i, j)$ th element in  $\mathbf{P}$ , where  $(i, j) \in \mathbb{N}$ .

The next subsections will derive the discretisation algorithms for systems with input delays, outputs delays and simultaneous input and output delays.

### 2.1 Systems with input delays

Consider a CT LTI system ( $\mathbf{A}$ ,  $\mathbf{B}$ ,  $\mathbf{C}$ ,  $\mathbf{D}$ ) with non-uniform input delays

$$\dot{\mathbf{x}}(t) = \mathbf{A}\mathbf{x}(t) + \mathbf{B}\mathbf{u}(t - \boldsymbol{\theta}) \tag{1}$$

$$\mathbf{y}(t) = \mathbf{C}\mathbf{x}(t) + \mathbf{D}\mathbf{u}(t - \boldsymbol{\theta}) \tag{2}$$

where  $\mathbf{A} \in \mathbb{R}^{n \times n}$ ,  $\mathbf{B} \in \mathbb{R}^{n \times r}$ ,  $\mathbf{C} \in \mathbb{R}^{m \times n}$  and  $\mathbf{D} \in \mathbb{R}^{m \times r}$ . If the inputs are not ordered as discussed previously, then ordering can be achieved by applying the permutation matrix  $\mathbf{Q} \in \mathbb{R}^{r \times r}$  to the system (1) and (2) to obtain the system with ordered inputs ( $\mathbf{A}$ ,  $\tilde{\mathbf{B}}$ ,  $\mathbf{C}$ ,  $\tilde{\mathbf{D}}$ ), where  $\tilde{\mathbf{B}} = \mathbf{B}\mathbf{Q}^{-1}$ ,  $\tilde{\mathbf{D}} = \mathbf{D}\mathbf{Q}^{-1}$  and  $\tilde{\mathbf{u}}(t - \boldsymbol{\theta}) = \mathbf{Q}\mathbf{u}(t - \boldsymbol{\theta})$ . The delay vectors will be decomposed as

$$\boldsymbol{\theta}_j = \begin{cases} 0, & j \in \mathcal{J}_{R_1} \triangleq \{1, 2, \dots, r_1\} \\ l_j T, & j \in \mathcal{J}_{R_2} \triangleq \{r_1 + 1, r_1 + 2, \dots, r_2\} \\ (1 - p_j)T, & j \in \mathcal{J}_{R_3} \triangleq \{r_2 + 1, r_2 + 2, \dots, r_3\} \\ (l_j - p_j)T, & j \in \mathcal{J}_{R_4} \triangleq \{r_3 + 1, r_3 + 2, \dots, r_4\} \end{cases}$$

where  $\{l_j = 2, 3, \dots; j \in \mathcal{J}_{R_4}\}$  and  $\{p_j \in (0, 1), j \in \mathcal{J}_{R_3}, j \in \mathcal{J}_{R_4}\}$ . The general solution for the state dynamics in (1) is

$$\mathbf{x}(t) = e^{\mathbf{A}(t-t_0)}\mathbf{x}(t_0) + \int_{t_0}^t e^{\mathbf{A}(t-\tau)}\mathbf{B}\mathbf{u}(\tau - \boldsymbol{\theta}) d\tau \tag{3}$$

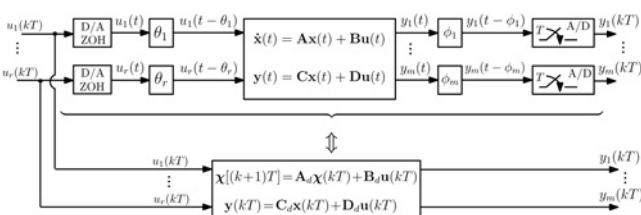

Fig. 1 CT MIMO LTI system with non-uniform input and output delays in the prototypical sampled-data system configuration and its DT equivalent

Letting  $t_0 = kT$  and  $t = (k + 1)T$  in (3), and using the change of variables  $\sigma = (k + 1)T - \tau$ , yields

$$\mathbf{x}[(k + 1)T] = \Phi(T)\mathbf{x}(kT) + \sum_{j=1}^r \int_0^T e^{A\sigma} \mathbf{b}_j u_j[(k + 1)T - \theta_j - \sigma] d\sigma \quad (4)$$

The integrals in (4) evaluate to

$$\mathbf{I}_j = \begin{cases} \boldsymbol{\psi}_j(T)u_j(kT), & j \in \mathcal{J}_{R_1} \\ \boldsymbol{\psi}_j(T)u_j[(k - l_j)T], & j \in \mathcal{J}_{R_2} \\ \boldsymbol{\psi}_j(p_j T)u_j(kT) + \boldsymbol{\lambda}_j(p_j T)u_j[(k - 1)T], & j \in \mathcal{J}_{R_3} \\ \boldsymbol{\psi}_j(p_j T)u_j[(k - l_j + 1)T] + \boldsymbol{\lambda}_j(p_j T)u_j[(k - l_j)T], & j \in \mathcal{J}_{R_4} \end{cases}$$

where we define  $\Phi(t)$ ,  $\boldsymbol{\psi}_j(t)$  and  $\boldsymbol{\lambda}_j(t)$  as

$$\Phi(t) \triangleq e^{At}, \quad \boldsymbol{\psi}_j(t) \triangleq \int_0^t e^{A\tau} d\tau \mathbf{b}_j, \quad \boldsymbol{\lambda}_j(t) \triangleq \Phi(t)\boldsymbol{\psi}_j(T - t)$$

In evaluating  $\{\mathbf{I}_j, j \in \mathcal{J}_{R_1}, j \in \mathcal{J}_{R_3}\}$  we used the ZOH assumption. In evaluating  $\{\mathbf{I}_j, j \in \mathcal{J}_{R_2}, j \in \mathcal{J}_{R_4}\}$  we used Fig. 2 and noted that in the interval  $\sigma \in [0, p_j T]$ , the input takes a piecewise constant value of  $u_j(kT)$ , whereas in the interval  $\sigma \in [p_j T, T]$  it takes a piecewise constant value of  $u_j[(k - 1)T]$ . In order to eliminate past inputs, we introduce the state variables

$$\xi_{R_3,j}(kT) \triangleq u_j[(k - 1)T], \quad j \in \mathcal{J}_{R_3} \quad (5)$$

$$\xi_{R_2,j,s}(kT) \triangleq u_j[(k - l_j + s - 1)T] \quad (6)$$

where  $\{z \equiv 2, j \in \mathcal{J}_{R_2}\}$ ,  $\{z \equiv 4, j \in \mathcal{J}_{R_4}\}$  and  $s = 1, \dots, l_j$ . Next, to discretise the output (2) we note that

$$u_j(kT - \theta_j) = \begin{cases} u_j(kT), & j \in \mathcal{J}_{R_1} \\ u_j[(k - 1)T], & j \in \mathcal{J}_{R_3} \\ u_j[(k - l_j)T], & \text{otherwise} \end{cases}$$

Finally, dropping the dependency of  $\Phi$  on  $T$  for simplicity of notation and defining the augmented DT state  $\boldsymbol{\chi}_I \triangleq [\mathbf{x}^T \boldsymbol{\xi}^T]^T$ , the DT equivalent SS model  $(\mathbf{A}_{d,I}, \mathbf{B}_{d,I}, \mathbf{C}_{d,I}, \mathbf{D}_{d,I})$  can be

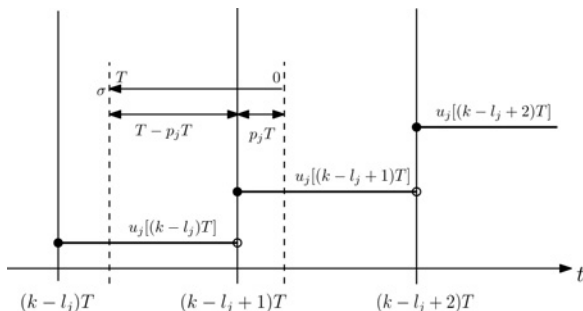

Fig. 2 Effect of input fractional time delay

expressed compactly as

$$\begin{aligned} \boldsymbol{\xi} &= [\boldsymbol{\xi}_{R_2,r_1+1}^T \cdots \boldsymbol{\xi}_{R_2,r_2}^T \boldsymbol{\xi}_{R_3}^T \boldsymbol{\xi}_{R_4,r_3+1}^T \cdots \boldsymbol{\xi}_{R_4,r_4}^T]^T \\ \boldsymbol{\xi}_{R_2,j} &= [\xi_{R_2,j,1} \quad \xi_{R_2,j,2} \quad \cdots \quad \xi_{R_2,j,l_j}]^T, \quad j \in \mathcal{J}_{R_2} \\ \boldsymbol{\xi}_{R_3} &= [\xi_{r_2+1} \quad \xi_{r_2+2} \quad \cdots \quad \xi_{r_3}]^T \\ \boldsymbol{\xi}_{R_4,j} &= [\xi_{R_4,j,1} \quad \xi_{R_4,j,2} \quad \cdots \quad \xi_{R_4,j,l_j}]^T, \quad j \in \mathcal{J}_{R_4} \\ \mathbf{A}_{d,I} &= \begin{bmatrix} \Phi & \Sigma_{R_2} & \Sigma_{R_3} & \Sigma_{R_4} \\ \mathbf{0} & \mathbf{J}_{R_2} & \mathbf{0} & \mathbf{0} \\ \mathbf{0} & \mathbf{0} & \mathbf{0} & \mathbf{0} \\ \mathbf{0} & \mathbf{0} & \mathbf{0} & \mathbf{J}_{R_4} \end{bmatrix} \\ \mathbf{B}_{d,I} &= \begin{bmatrix} \Psi_{R_1} & \mathbf{0} & \Omega_{R_3} & \mathbf{0} \\ \mathbf{0} & \mathbf{E}_{R_2} & \mathbf{0} & \mathbf{0} \\ \mathbf{0} & \mathbf{0} & \mathbf{I} & \mathbf{0} \\ \mathbf{0} & \mathbf{0} & \mathbf{0} & \mathbf{E}_{R_4} \end{bmatrix} \\ \mathbf{C}_{d,I} &= [\mathbf{C} \quad \mathbf{F}_{R_2} \quad \mathbf{D}_{R_3} \quad \mathbf{F}_{R_4}], \quad \mathbf{D}_{d,I} = [\mathbf{D}_{R_1} \quad \mathbf{0} \quad \mathbf{0} \quad \mathbf{0}] \end{aligned}$$

Explicit expressions for the matrix blocks of the DT equivalent SS model are given in Appendix (Section 7.1).

## 2.2 Systems with output delays

Consider a CT LTI system with output delays

$$\dot{\mathbf{x}}(t) = \mathbf{A}\mathbf{x}(t) + \mathbf{B}\mathbf{u}(t) \quad (7)$$

$$\mathbf{y}(t + \boldsymbol{\phi}) = \mathbf{C}\mathbf{x}(t) + \mathbf{D}\mathbf{u}(t) \quad (8)$$

If the outputs are not ordered as discussed previously, then ordering can be achieved by applying the permutation matrix  $\mathbf{R} \in \mathbb{R}^{m \times m}$  to the system in (7) and (8) to obtain the system with ordered outputs,  $(\mathbf{A}, \mathbf{B}, \hat{\mathbf{C}}, \hat{\mathbf{D}})$ , where  $\hat{\mathbf{C}} = \mathbf{R}\mathbf{C}$ ,  $\hat{\mathbf{D}} = \mathbf{R}\mathbf{D}$  and  $\hat{\mathbf{y}}(t + \boldsymbol{\phi}) = \mathbf{R}\mathbf{y}(t + \boldsymbol{\phi})$ .

The delay vectors will be decomposed as

$$\boldsymbol{\phi}_i = \begin{cases} 0, & i \in \mathcal{I}_{M_1} \triangleq \{1, 2, \dots, m_1\} \\ h_i T, & i \in \mathcal{I}_{M_2} \triangleq \{m_1 + 1, \dots, m_2\} \\ (1 - q_i)T, & i \in \mathcal{I}_{M_3} \triangleq \{m_2 + 1, \dots, m_3\} \\ (h_i - q_i)T, & i \in \mathcal{I}_{M_4} \triangleq \{m_3 + 1, \dots, m_4\} \end{cases}$$

where  $\{h_i \in \mathbb{N}, i \in \mathcal{I}_{M_2}\}$ ,  $\{h_i = 2, 3, \dots; i \in \mathcal{I}_{M_4}\}$  and  $\{q_j \in (0, 1), i \in \mathcal{I}_{M_3}, i \in \mathcal{I}_{M_4}\}$ . Discretising the state equation in (7) and the output equation in (8), we obtain

$$\mathbf{x}[(k + 1)T] = \Phi(T)\mathbf{x}(kT) + \Psi(T)\mathbf{u}(kT)$$

$$\Psi(t) \triangleq [\boldsymbol{\psi}_1(t) \quad \boldsymbol{\psi}_2(t) \quad \cdots \quad \boldsymbol{\psi}_r(t)]$$

$$y_i(kT) = \begin{cases} \mathbf{c}_i^T \mathbf{x}(kT) + \mathbf{d}_i^T \mathbf{u}(kT), & i \in \mathcal{I}_{M_1} \\ \mathbf{c}_i^T \mathbf{x}[(k - h_i)T] + \mathbf{d}_i^T \mathbf{u}[(k - h_i)T], & i \in \mathcal{I}_{M_2} \\ \mathbf{c}_i^T \mathbf{x}[(k - 1 + q_i)T] + \mathbf{d}_i^T \mathbf{u}[(k - 1 + q_i)T], & i \in \mathcal{I}_{M_3} \\ \mathbf{c}_i^T \mathbf{x}[(k - h_i + q_i)T] + \mathbf{d}_i^T \mathbf{u}[(k - h_i + q_i)T], & i \in \mathcal{I}_{M_4} \end{cases}$$

In order to capture the effect of the delayed signal

$y_i[(k + h_i)T]$ , we introduce  $h_i$  state variables such that

$$\eta_{M_z,i,s}(kT) \triangleq y_i[(k + h_i - s)T] \quad (9)$$

where  $\{z \equiv 2, i \in \mathcal{I}_{M_z}\}$  and  $s = 1, 2, \dots, h_i$ . The term  $\mathbf{x}[(k - 1 + q_i)T]$  can be evaluated by starting with the solution of the state dynamics in (3) with  $\boldsymbol{\theta} \equiv \mathbf{0}$ , letting  $t_0 = (k - 1)T$  and  $t = kT - (1 - q_i)T$ , noting that  $\mathbf{u}(t) = \mathbf{u}[(k - 1)T]$  for  $[(k - 1)T \leq t < (k - 1 + q_i)T < kT]$  for any  $q_i \in (0, 1)$ , and finally using the change of variable  $\sigma = [(k - 1 + q_i)T - \tau]$  to arrive at

$$\mathbf{x}[(k - 1 + q_i)T] = \boldsymbol{\Phi}(q_i T)\mathbf{x}[(k - 1)T] + \boldsymbol{\Psi}(q_i T)\mathbf{u}[(k - 1)T]$$

To evaluate  $\mathbf{u}[(k - 1 + q_i)T]$ , we note that under ZOH,  $\mathbf{u}[(k - 1 + q_i)T] = \mathbf{u}[(k - 1)T]$ , for any  $q_i \in (0, 1)$ . In order to capture the effect of the delayed signal  $y_i[(k + h_i - q_i)T]$ , we introduce  $h_i$  state variables, which will be identical to the ones defined in (9) with  $\{z \equiv 4, i \in \mathcal{I}_{M_4}\}$ . In order to evaluate  $\eta_{M_4,i,1}(kT)$ , we start with  $y_i[(k + h_i - q_i)T]$  and proceed to find that

$$y_i[(k + h_i - 1)T] = \mathbf{c}_i^T \mathbf{x}[(k - 1 + q_i)T] + \mathbf{d}_i^T \mathbf{u}[(k - 1 + q_i)T]$$

Finally, dropping the dependency of  $(\boldsymbol{\Phi}, \boldsymbol{\Psi})$  on  $T$ , defining the augmented DT state  $\boldsymbol{\chi}_O \triangleq [\mathbf{x}^T \boldsymbol{\eta}^T]^T$ , the DT equivalent SS model  $(\mathbf{A}_{d,O}, \mathbf{B}_{d,O}, \mathbf{C}_{d,O}, \mathbf{D}_{d,O})$  can be expressed as

$$\boldsymbol{\eta} \triangleq \left[ \boldsymbol{\eta}_{M_2,m_1+1}^T \cdots \boldsymbol{\eta}_{M_2,m_2}^T \boldsymbol{\eta}_{M_3}^T \boldsymbol{\eta}_{M_4,m_3+1}^T \cdots \boldsymbol{\eta}_{M_4,m_4}^T \right]^T$$

$$\boldsymbol{\eta}_{M_2,i} \triangleq \left[ \eta_{M_2,i,1} \ \eta_{M_2,i,2} \ \cdots \ \eta_{M_2,i,h_i} \right]^T, \quad i \in \mathcal{I}_{M_2}$$

$$\boldsymbol{\eta}_{M_3} \triangleq \left[ \eta_{m_2+1} \ \eta_{m_2+2} \ \cdots \ \eta_{m_3} \right]^T$$

$$\boldsymbol{\eta}_{M_4,i} \triangleq \left[ \eta_{M_4,i,1} \ \eta_{M_4,i,2} \ \cdots \ \eta_{M_4,i,h_i} \right]^T, \quad i \in \mathcal{I}_{M_4}$$

$$\mathbf{A}_{d,O} = \begin{bmatrix} \boldsymbol{\Phi} & \mathbf{0} & \mathbf{0} & \mathbf{0} \\ \boldsymbol{\Lambda}_{M_2} & \mathbf{H}_{M_2} & \mathbf{0} & \mathbf{0} \\ \boldsymbol{\Lambda}_{M_3} & \mathbf{0} & \mathbf{0} & \mathbf{0} \\ \boldsymbol{\Lambda}_{M_4} & \mathbf{0} & \mathbf{0} & \mathbf{H}_{M_4} \end{bmatrix}, \quad \mathbf{B}_{d,O} = \begin{bmatrix} \boldsymbol{\Psi} \\ \mathbf{Y}_{M_2} \\ \mathbf{Y}_{M_3} \\ \mathbf{Y}_{M_4} \end{bmatrix}$$

$$\mathbf{C}_{d,O} = \text{diag}[\mathbf{C}_{M_1}, \mathbf{G}_{M_2}, \mathbf{I}, \mathbf{G}_{M_4}], \quad \mathbf{D}_{d,O} = \begin{bmatrix} \mathbf{D}_{M_1}^T & \mathbf{0} & \mathbf{0} & \mathbf{0} \end{bmatrix}$$

Explicit expressions for the matrix blocks of the DT equivalent SS model are given in Appendix (Section 7.2).

### 2.3 Systems with input and output delays

Consider a CT LTI system with input and output delays

$$\dot{\mathbf{x}}(t) = \mathbf{A}\mathbf{x}(t) + \mathbf{B}\mathbf{u}(t - \boldsymbol{\theta}) \quad (10)$$

$$\mathbf{y}(t + \boldsymbol{\phi}) = \mathbf{C}\mathbf{x}(t) + \mathbf{D}\mathbf{u}(t - \boldsymbol{\theta}) \quad (11)$$

If the inputs and outputs are not ordered as discussed previously, then applying the permutation matrices  $(\mathbf{Q}, \mathbf{R})$  to (10) and (11) yields the ordered system  $(\mathbf{A}, \mathbf{B}, \mathbf{C}, \mathbf{D})$ , where  $\bar{\mathbf{B}} = \mathbf{B}\mathbf{Q}^{-1}$ ,  $\bar{\mathbf{C}} = \mathbf{R}\mathbf{C}$ ,  $\bar{\mathbf{D}} = \mathbf{R}\mathbf{D}\mathbf{Q}^{-1}$ ,  $\bar{\mathbf{u}}(t - \boldsymbol{\theta}) = \mathbf{Q}\mathbf{u}(t - \boldsymbol{\theta})$  and  $\bar{\mathbf{y}}(t + \boldsymbol{\phi}) = \mathbf{R}\mathbf{y}(t + \boldsymbol{\phi})$ . The system states are affected by the input but not the output delays. Consequently, the state (10) DT equivalent is derived as

was shown in Section 2.1. Next, we consider the discretisation of the output (11). First, for each  $\{y_i, i \in \mathcal{I}_{M_1}\}$ , we note that this is identical to discretising the output equation with input delays only. Consequently, the DT equivalent is nothing but

$$y_i(kT) = \mathbf{c}_i^T \mathbf{x}(kT) + \mathbf{d}_{R_1,i}^T \mathbf{u}_{R_1}(kT) + \mathbf{d}_{R_2,i}^T \boldsymbol{\xi}_{R_2,R_2,1}(kT) + \mathbf{d}_{R_3,i}^T \boldsymbol{\xi}_{R_3}(kT) + \mathbf{d}_{R_4,i}^T \boldsymbol{\xi}_{R_4,R_4,1}(kT), \quad i \in \mathcal{I}_{M_1}$$

$$\mathbf{d}_{R_1,i}^T = [d_{i,1} \ \cdots \ d_{i,r_1}], \quad \mathbf{d}_{R_2,i}^T = [d_{i,r_1+1} \ \cdots \ d_{i,r_2}]$$

$$\mathbf{d}_{R_3,i}^T = [d_{i,r_2+1} \ \cdots \ d_{i,r_3}], \quad \mathbf{d}_{R_4,i}^T = [d_{i,r_3+1} \ \cdots \ d_{i,r_4}]$$

$$\boldsymbol{\xi}_{R_2,R_2,1}(kT) \triangleq [\xi_{R_2,r_1+1,1}(kT) \ \cdots \ \xi_{R_2,r_2,1}(kT)]^T$$

$$\boldsymbol{\xi}_{R_4,R_4,1}(kT) \triangleq [\xi_{R_4,r_3+1,1}(kT) \ \cdots \ \xi_{R_4,r_4,1}(kT)]^T$$

Second, for each  $\{y_i, i \in \mathcal{I}_{M_2}\}$ , we introduce  $h_i$  state variables, as defined in (9). To calculate  $\eta_{M_2,i,1}[(k + 1)T]$ , we consider the effect of each of the delayed inputs. First, we note that each  $\{u_j, j \in \mathcal{J}_{R_2}\}$  corresponds to the state variable  $\xi_{R_2,j,1}(kT)$  that was introduced in (6). Second, we note that under ZOH,  $u_j[(k - 1 + p_j)T] = u_j[(k - 1)T]$  for any  $p_j \in (0, 1)$  and for all  $\{u_j, j \in \mathcal{J}_{R_3}\}$ . Similarly, we note that under ZOH,  $u_j[(k - l_j + p_j)T] = u_j[(k - l_j)T]$  for any  $p_j \in (0, 1)$  and any  $l_j = 2, 3, \dots$ , and for all  $\{u_j, j \in \mathcal{J}_{R_4}\}$ . Hence, we may express

$$\eta_{M_2,i,1}[(k + 1)T] = \mathbf{c}_i^T \mathbf{x}(kT) + \mathbf{d}_{R_1,i}^T \mathbf{u}_{R_1}(kT) + \mathbf{d}_{R_3,i}^T \boldsymbol{\xi}_{R_3} + \mathbf{d}_{R_2,i}^T \boldsymbol{\xi}_{R_2,R_2,1} + \mathbf{d}_{R_4,i}^T \boldsymbol{\xi}_{R_4,R_4,1}$$

where  $i \in \mathcal{I}_{M_2}$ . Third, for each  $\{y_i, i \in \mathcal{I}_{M_3}\}$ , the DT equivalent output equation is given by

$$y_i(kT) = \mathbf{c}_i^T \mathbf{x}[(k - 1 + q_i)T] + \mathbf{d}_i^T \mathbf{u}[(k - 1 + q_i)T - \boldsymbol{\theta}] \quad (12)$$

To evaluate  $\mathbf{x}[(k - 1 + q_i)T]$ , we use the change of variables  $\sigma = kT - (1 - q_i)T - \tau$  in (3) to obtain

$$\mathbf{x}[(k - 1 + q_i)T] = \boldsymbol{\Phi}(q_i T)\mathbf{x}[(k - 1)T] + \sum_{s=1}^4 \sum_{j \in \mathcal{J}_{R_s}} \mathbf{I}_{R_s,j,i}$$

$$\mathbf{I}_{R_s,j,i} \triangleq \int_0^{q_i T} e^{\mathbf{A}\sigma} \mathbf{b}_j u_j[(k - 1 + q_i)T - \boldsymbol{\theta}_j - \sigma] d\sigma$$

The integrals  $\mathbf{I}_{R_1,j,i}$  and  $\mathbf{I}_{R_2,j,i}$  can be evaluated with the aid of Fig. 3 by noting that in the interval  $\sigma \in [0, q_i T]$ , the input signal takes a piecewise constant value of  $u_j[(k - 1 - l_j)T]$ , so we obtain

$$\mathbf{I}_{R_s,j,i} = \begin{cases} \boldsymbol{\psi}_j(q_i T) u_j[(k - 1)T], & s = 1 \\ \boldsymbol{\psi}_j(q_i T) u_j[(k - 1 - l_j)T], & s = 2 \end{cases}$$

The integrals  $\mathbf{I}_{R_3,j,i}$  and  $\mathbf{I}_{R_4,j,i}$  can be evaluated with the aid of Figs. 4 and 5, where Fig. 4 depicts the case where  $0 < p_j + q_i < 1$ , whereas Fig. 5 depicts the case where  $1 \leq p_j + q_i < 2$ . For the former case, we note that in the interval  $\sigma \in [0, q_i T]$ , the input signal takes a piecewise constant value of  $u_j[(k - 1 - l_j)T]$ . However, in the latter case, the input takes a piecewise constant value of

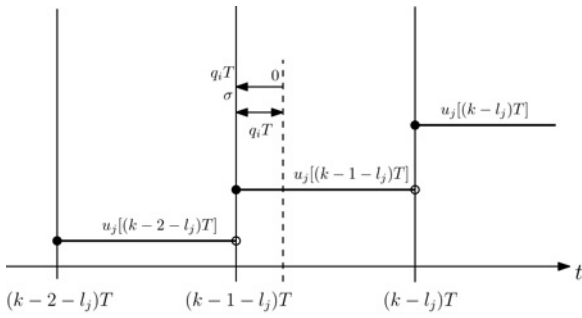

Fig. 3 Effect of input and output delay on  $u_{R_1}$  and  $u_{R_2}$

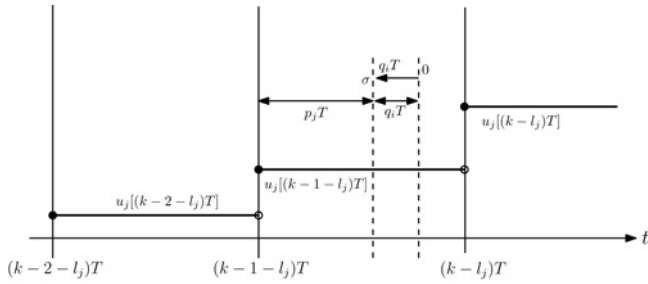

Fig. 4 Effect of input and output time delays on  $u_{R_3}$  and  $u_{R_4}$  with  $0 < p_j + q_i < 1$

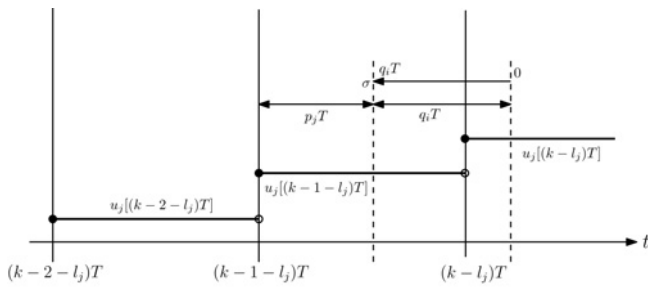

Fig. 5 Effect of input and output time delays on  $u_{R_3}$  and  $u_{R_4}$  with  $1 \leq p_j + q_i < 2$

$u_j[(k-l_j)T]$  in the interval  $\sigma \in [0, (p_j + q_i - 1)T]$  and then switches to the constant value of  $u_j[(k-1-l_j)T]$  in the interval  $\sigma \in [(p_j + q_i - 1)T, q_i T]$ . Therefore

$$\mathbf{I}_{R_z,j,i} = \begin{cases} \boldsymbol{\psi}_j(q_i T) u_j[(k-1-l_j)T], & 0 < q_i + p_j < 1; \\ \boldsymbol{\psi}_j[(q_i + p_j - 1)T] u_j[(k-l_j)T] \\ + \boldsymbol{\Phi}[(q_i + p_j - 1)T] \boldsymbol{\psi}_j[(1-p_j)T] \\ \times u_j[(k-1-l_j)T], & 1 \leq q_i + p_j < 2 \end{cases}$$

$$= \boldsymbol{\delta}_{R_z,j,i} u_j[(k-l_j)T] + \boldsymbol{\gamma}_{R_z,j,i} u_j[(k-1-l_j)T]$$

$$\boldsymbol{\delta}_{R_z,j,i} = \begin{cases} \mathbf{0}, & 0 < q_i + p_j < 1 \\ \boldsymbol{\psi}_j[(q_i + p_j - 1)T], & 1 \leq q_i + p_j < 2 \end{cases}$$

$$\boldsymbol{\gamma}_{R_z,j,i} = \begin{cases} \boldsymbol{\psi}_j(q_i T), & 0 < q_i + p_j < 1 \\ \boldsymbol{\Phi}[(q_i + p_j - 1)T] \\ \times \boldsymbol{\psi}_j[(1-p_j)T], & 1 \leq q_i + p_j < 2 \end{cases}$$

where  $z = \{3, 4\}$  and  $l_j = 1$  whenever  $z = 3$ .

Next, we will evaluate the inputs in (12). First, we know that under ZOH  $u_j[(k-1+q_i)T] = u_j[(k-1)T]$ , for

$j \in \mathcal{J}_{R_1}$ , and  $u_j[(k-1_{R_2} - 1 + q_i)T] = u_j[(k-1_{R_2} - 1)T]$ , for  $j \in \mathcal{J}_{R_2}$  and any  $q_i \in (0, 1)$ .

Moreover

$$u_j[(k-1-l_j+p_j+q_i)T] = \begin{cases} u_j[(k-1-l_j)T], & 0 < q_i + p_j < 1 \\ u_j[(k-l_j)T], & 1 \leq q_i + p_j < 2 \end{cases}$$

where  $\{l_j = 1, j \in \mathcal{J}_{R_3}\}$  and  $j \in \mathcal{J}_{R_4}$ . Therefore we can express the  $R_3$  and  $R_4$  inputs compactly as

$$\mathbf{u}_{R_z}[(k-1_{R_z} + p_{R_z} - 1 + q_i)T] = \mathbf{V}_{R_z,i} \mathbf{u}_{R_z}[(k-l_j)T] + \mathbf{W}_{R_z,i} \mathbf{u}_{R_z}[(k-1-l_j)T]$$

$$\mathbf{V}_{R_z,i} = \text{diag}[v_{R_z,i,11}, v_{R_z,i,22}, \dots, v_{R_z,i,j_z T_z}]$$

$$v_{R_z,i,ff} = \begin{cases} 0, & 0 < q_i + p_j < 1 \\ 1, & 1 \leq q_i + p_j < 2 \end{cases}$$

where  $z = \{3, 4\}$ ,  $\mathbf{I}_{R_z} = \mathbf{1}$  whenever  $z = 3$ ,  $f \in \mathcal{F}_{R_z} \triangleq \{1, 2, \dots, R_z\}$  and  $\mathbf{W}_{R_z,i} = \mathbf{I} - \mathbf{V}_{R_z,i}$ . Combining  $\mathbf{x}[(k-1+q_i)T]$  and the different inputs we obtain  $y_i(kT)$ , which upon advancing one sample yields the signal that will be augmented to the state vector

$$y_i[(k+1)T] = \mathbf{c}_i^T \{ \boldsymbol{\Phi}(q_i T) \mathbf{x}(kT) + [\mu_{R_1,1,i} \dots \mu_{R_1,j_1,i}] \mathbf{u}_{R_1}(kT) + [\mu_{R_2,j_1+1,i} \dots \mu_{R_2,j_2,i}] \boldsymbol{\xi}_{R_2,R_2,1}(kT) + [\pi_{R_3,j_2+1,i} \dots \pi_{R_3,j_3,i}] \mathbf{u}_{R_3}(kT) + [\rho_{R_3,j_2+1,i} \dots \rho_{R_3,j_3,i}] \boldsymbol{\xi}_{R_3}(kT) + [\pi_{R_4,j_3+1,i} \dots \pi_{R_4,j_4,i}] \boldsymbol{\xi}_{R_4,R_4,2}(kT) + [\rho_{R_4,j_3+1,i} \dots \rho_{R_4,j_4,i}] \boldsymbol{\xi}_{R_4,R_4,1}(kT) \}$$

where

$$\boldsymbol{\xi}_{R_4,R_4,2}(kT) = [\xi_{R_4,j_3+1,2}(kT) \dots \xi_{R_4,j_4,2}(kT)]^T$$

$$\mu_{R_1,j,i} = \boldsymbol{\psi}_j(q_i T) + d_{R_1,j,i}, \quad j \in \mathcal{J}_{R_1}$$

$$\mu_{R_2,j,i} = \boldsymbol{\psi}_j(q_i T) + d_{R_2,j,i}, \quad j \in \mathcal{J}_{R_2}$$

$$\pi_{R_3,j,i} = \boldsymbol{\delta}_{R_3,j,i} + \mathbf{d}_{R_3,i}^T \mathbf{v}_{R_3,i,f}, \quad j \in \mathcal{J}_{R_3}, \quad f \in \mathcal{F}_{R_3}$$

$$\rho_{R_3,j,i} = \boldsymbol{\gamma}_{R_3,j,i} + \mathbf{d}_{R_3,i}^T \mathbf{w}_{R_3,i,f}, \quad j \in \mathcal{J}_{R_3}, \quad f \in \mathcal{F}_{R_3}$$

$$\pi_{R_4,j,i} = \boldsymbol{\delta}_{R_4,j,i} + \mathbf{d}_{R_4,i}^T \mathbf{v}_{R_4,i,f}, \quad j \in \mathcal{J}_{R_4}, \quad f \in \mathcal{F}_{R_4}$$

$$\rho_{R_4,j,i} = \boldsymbol{\gamma}_{R_4,j,i} + \mathbf{d}_{R_4,i}^T \mathbf{w}_{R_4,i,f}, \quad j \in \mathcal{J}_{R_4}, \quad f \in \mathcal{F}_{R_4}$$

Fourth, for each  $\{y_i, i \in \mathcal{I}_{M_4}\}$ , we introduce  $h_i$  states as defined in (9) with  $\{z = 4, i \in \mathcal{I}_{M_4}\}$ . To evaluate  $\eta_{M_4,i,1}(kT) = y_i[(k+h_i-1)T]$ , it is easy to establish that

$$y_i[(k+h_i-1)T] = \mathbf{c}_i^T \mathbf{x}[(k-1+q_i)T] + \mathbf{d}_i^T \mathbf{u}[(k-1+q_i)T - \boldsymbol{\theta}]$$

The term  $\mathbf{x}[(k-1+q_i)T]$  and the contributions from different inputs have been evaluated when computing (12).

Finally, defining the augmented DT state  $\chi_{IO} \triangleq [\mathbf{x}^T \ \xi^T \ \eta^T]^T$ , the equivalent SS model  $(\mathbf{A}_{d,IO}, \mathbf{B}_{d,IO}, \mathbf{C}_{d,IO}, \mathbf{D}_{d,IO})$  can be expressed as

$$\mathbf{A}_{d,IO} = \begin{bmatrix} \mathbf{A}_{d,IO,11} & \mathbf{A}_{d,IO,12} \\ \mathbf{A}_{d,IO,21} & \mathbf{A}_{d,IO,22} \end{bmatrix}, \quad \mathbf{B}_{d,IO} = \begin{bmatrix} \mathbf{B}_{d,IO,11} \\ \mathbf{B}_{d,IO,21} \end{bmatrix}$$

$$\mathbf{C}_{d,IO} = [\mathbf{C}_{d,IO,11} \ \mathbf{C}_{d,IO,12}]$$

$$\mathbf{A}_{d,IO,11} \equiv \mathbf{A}_{d,I}, \quad \mathbf{A}_{d,IO,12} \equiv \mathbf{0}, \quad \mathbf{B}_{d,IO,11} \equiv \mathbf{B}_{d,I}$$

$$\mathbf{A}_{d,IO,12} = \begin{bmatrix} \Lambda_{M_2} & \mathbf{L}_{M_2} & \Xi_{M_2} & \mathbf{N}_{M_2} \\ \Lambda_{M_3} & \mathbf{L}_{M_3} & \Xi_{M_3} & \mathbf{N}_{M_3} \\ \Lambda_{M_4} & \mathbf{L}_{M_4} & \Xi_{M_4} & \mathbf{N}_{M_4} \end{bmatrix}$$

$$\mathbf{A}_{d,IO,22} = \begin{bmatrix} \mathbf{H}_{M_2} & \mathbf{0} & \mathbf{0} \\ \mathbf{0} & \mathbf{0} & \mathbf{0} \\ \mathbf{0} & \mathbf{0} & \mathbf{H}_{M_4} \end{bmatrix}$$

$$\mathbf{B}_{d,IO,21} = \begin{bmatrix} \Pi_{M_2,R_1} & \mathbf{0} & \mathbf{0} & \mathbf{0} \\ \Pi_{M_3,R_1} & \mathbf{0} & \Pi_{M_3,R_3} & \mathbf{0} \\ \Pi_{M_4,R_1} & \mathbf{0} & \Pi_{M_4,R_3} & \mathbf{0} \end{bmatrix}$$

$$\mathbf{C}_{d,IO,11} = \begin{bmatrix} \mathbf{C}_{M_1} & \mathbf{F}_{M_1,R_2} & \mathbf{D}_{M_1,R_3} & \mathbf{F}_{M_1,R_4} \\ \mathbf{0} & \mathbf{0} & \mathbf{0} & \mathbf{0} \\ \mathbf{0} & \mathbf{0} & \mathbf{0} & \mathbf{0} \\ \mathbf{0} & \mathbf{0} & \mathbf{0} & \mathbf{0} \end{bmatrix}$$

$$\mathbf{C}_{d,IO,12} = \begin{bmatrix} \mathbf{0} & \mathbf{0} & \mathbf{0} \\ \mathbf{G}_{M_2} & \mathbf{0} & \mathbf{0} \\ \mathbf{0} & \mathbf{I} & \mathbf{0} \\ \mathbf{0} & \mathbf{0} & \mathbf{G}_{M_4} \end{bmatrix}, \quad \mathbf{D}_{d,IO} = \begin{bmatrix} \mathbf{D}_{M_1,R_1} & \mathbf{0} & \mathbf{0} & \mathbf{0} \\ \mathbf{0} & \mathbf{0} & \mathbf{0} & \mathbf{0} \\ \mathbf{0} & \mathbf{0} & \mathbf{0} & \mathbf{0} \\ \mathbf{0} & \mathbf{0} & \mathbf{0} & \mathbf{0} \end{bmatrix}$$

Explicit expressions for the matrix blocks of the DT equivalent SS model are given in Appendix (Section 7.3).

### 3 Example

This section illustrates the application of the algorithm derived in Section 2 into discretising a fourth-order heat exchanger process with four inputs and four outputs, where each of the delays happen to be one of the four different delay cases. The system under study consists of two sets of single shell heat exchangers filled with water, placed in parallel and cooled by a liquid saturated refrigerant flowing

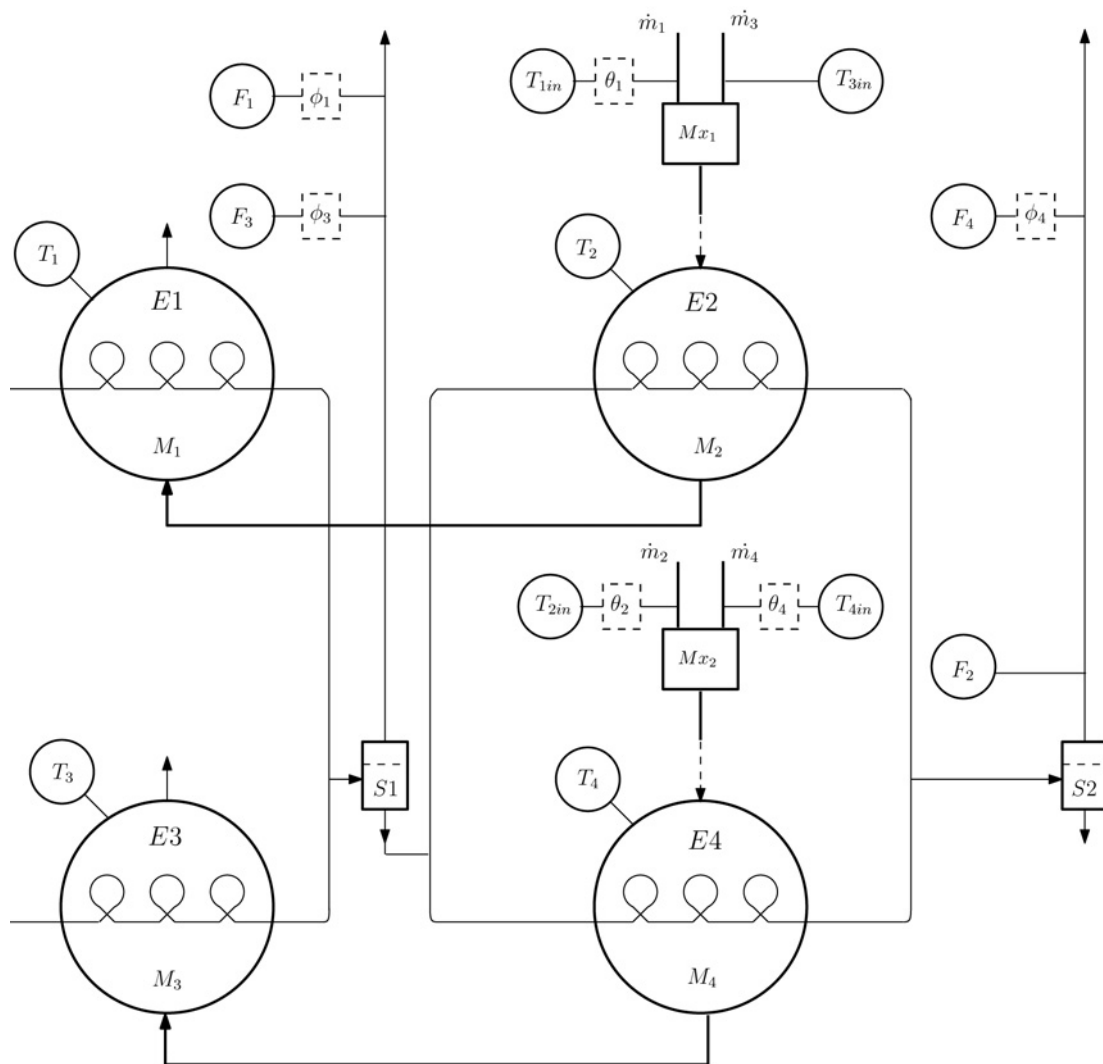

Fig. 6 Heat exchanger process with non-uniform input and output delays

Inlet temperatures  $T_{1in}, \dots, T_{4in}$  are the system inputs, while vapour flows  $F_1, \dots, F_4$  are the outputs

through a coil system, as it is illustrated in Fig. 6. The saturated vapour generated in the coil system is separated from the liquid phase in the stages  $S1$  and  $S2$ , both of neglected volumes. This vapour, withdrawn in  $S1$  and  $S2$ , reduces the refrigerant mass flow rate along the cooling system, and only the saturated liquid portion is used for cooling purposes. Table 1 provides the fluid properties and equipment dimensions. The temperature of the refrigerant remains constant at  $T_c$  as the liquid is saturated, and the energy exchanged with water is used to vapourise a small portion of the refrigerant fluid. The energy balance around each heat exchanger is given by

$$M_1 C_p \frac{dT_1}{dt} = (\dot{m}_1 + \dot{m}_3) C_p [T_2(t) - T_1(t)] - Q_1(t)$$

$$M_2 C_p \frac{dT_2}{dt} = \dot{m}_1 C_p T_{1in}(t - \theta_1) + \dot{m}_3 C_p T_{3in}(t - \theta_3) - (\dot{m}_1 + \dot{m}_3) C_p T_2(t) - Q_2(t)$$

$$M_3 C_p \frac{dT_3}{dt} = (\dot{m}_2 + \dot{m}_4) C_p [T_4(t) - T_3(t)] - Q_3(t)$$

$$M_4 C_p \frac{dT_4}{dt} = \dot{m}_2 C_p T_{2in}(t - \theta_2) + \dot{m}_4 C_p T_{4in}(t - \theta_4) - (\dot{m}_2 + \dot{m}_4) C_p T_4(t) - Q_4(t)$$

where  $Q_s, s = 1, \dots, 4$ , is the heat exchanged in  $E_s$ , which is estimated using the overall surface heat transfer coefficient and the refrigerant temperature  $T_c$ , such that  $Q_s(t) = hA[T_s(t) - T_c], s = 1, \dots, 4$ . The input time delays  $\theta_j$  in the inlet water temperatures are due to the transportation time, such that  $\theta_j = V_j \rho / \dot{m}_j, j = \{1, 2, 4\}$ . This implies that the inputs are delayed by the vector  $\theta = [0.5 \ 2 \ 0 \ 1.5]^T$ . The measured output flow  $F_i$  is expressed as  $F_i(t + \phi_i) = [Q_i(t) + Q_{i+2}(t)]/h_{iv}, i = 1, \dots, 4$ , where  $h_{iv}$  is the refrigerant heat of vapourisation.

These outputs are delayed by  $\phi = [2.4 \ 0 \ 0.6 \ 4]^T$ , which are due to fluid property compensators. The individual heat exchanger energy balances can be expressed in terms of deviation variables to define the following LTI

**Table 1** Fluid properties and equipment dimensions for the process

$C_p$	4.217 kJ/kg K	water specific heat
$h_{iv}$	850 kJ/kg	refrigerant heat of vapourisation
$T_s(0)$	40°C	initial temperature in $E_s$
$T_{jin}(0)$	40°C	initial water inlet temperature $j$
$T_c$	40°C	refrigerant temperature
$\dot{m}_j$	1 kg/s	water mass flow $j$
$M_s$	50 kg	mass of water in $E_s$
$hA$	8 kJ/kg	overall surface heat transfer
$V_1$	$0.5 \times 10^{-3} \text{ m}^3$	inlet water pipe volume 1
$V_2$	$2 \times 10^{-3} \text{ m}^3$	inlet water pipe volume 2
$V_4$	$1.5 \times 10^{-3} \text{ m}^3$	inlet water pipe volume 4
$\rho$	1000 kg/m <sup>3</sup>	water density

system

$$A = \begin{bmatrix} -\frac{(1 + v_A)}{\tau_1} & \frac{1}{\tau_1} & 0 & 0 \\ 0 & -\frac{(1 + v_A)}{\tau_2} & 0 & 0 \\ 0 & 0 & -\frac{(1 + v_B)}{\tau_3} & \frac{1}{\tau_3} \\ 0 & 0 & 0 & -\frac{(1 + v_B)}{\tau_4} \end{bmatrix}$$

$$B = \begin{bmatrix} \frac{0}{\kappa_1} & 0 & \frac{0}{\kappa_3} & 0 \\ \frac{\tau_2}{\tau_2} & 0 & \frac{\tau_2}{\tau_2} & 0 \\ 0 & \frac{0}{\kappa_2} & 0 & \frac{0}{\kappa_4} \\ 0 & \frac{\tau_4}{\tau_4} & 0 & \frac{\tau_4}{\tau_4} \end{bmatrix}, \quad C = \begin{bmatrix} \mu & 0 & \mu & 0 \\ 0 & \mu & 0 & \mu \\ \mu & 0 & \mu & 0 \\ 0 & \mu & 0 & \mu \end{bmatrix}$$

$$D = [0]$$

where  $v_A \triangleq (hA/C_p)(\dot{m}_1 + \dot{m}_3)$ ,  $v_B \triangleq (hA/C_p)(\dot{m}_2 + \dot{m}_4)$ ,  $\tau_1 \triangleq (M_1/(\dot{m}_1 + \dot{m}_3))$ ,  $\tau_2 \triangleq (M_2/(\dot{m}_1 + \dot{m}_3))$ ,  $\tau_3 \triangleq (M_3/(\dot{m}_2 + \dot{m}_4))$ ,  $\tau_4 \triangleq (M_4/(\dot{m}_4 + \dot{m}_3))$ ,  $\kappa_1 \triangleq (\dot{m}_1/(\dot{m}_1 + \dot{m}_3))$ ,  $\kappa_2 \triangleq (\dot{m}_2/(\dot{m}_2 + \dot{m}_4))$ ,  $\kappa_3 \triangleq (\dot{m}_3/(\dot{m}_1 + \dot{m}_3))$ ,  $\kappa_4 \triangleq (\dot{m}_4/(\dot{m}_2 + \dot{m}_4))$  and  $\mu \triangleq (hA/h_{iv})$ . This system was discretised with a sampling time of  $T = 1$  s using the algorithm outlined in Section 2 and was discretised while rounding the input and output delays to the closest integer-multiples of  $T$ .

The systems were driven by step inputs of amplitudes  $\{5, -5, 5, -5\}$  that were applied at time instants  $\{1, 10, 1, 10\}$  seconds, respectively. The LabVIEW control design and simulation module was used to define the system dynamics with the appropriate input and output delays and simulate the CT system and its DT equivalents. Fig. 7 shows the block diagram of the simulated systems. Fig. 8 illustrates the output responses of the three systems over 40 s. We can note the response mismatch of the DT system that rounds the delay to the nearest integer-multiple of the sampling time. None of its response points lie on the CT system response line. However, the response obtained by the DT system that compensates for the delays matches exactly the CT system response at the precise sampling instants.

Table 2 quantifies the detrimental effect of rounding the input and output delays. The average relative percentage error along the simulation time is used to determine the accuracy of the approximation relative to the magnitude of the actual response, defined by

$$\varepsilon_i = \frac{1}{N} \sum_{k=1}^N \frac{|y_{ci}(kT) - y_{di}(kT)|}{y_{ci}(kT)} \times 100\%, \quad i = 1, \dots, 4, \\ N = 40$$

Here,  $y_{ci}$  and  $y_{di}$  represent the CT and DT responses for output  $i$ . It can be noted from Table 2 that the average errors for the ZOH method that rounds the delays are significant compared to the ZOH method that compensates for the delays by incorporating them into the DT equivalent model.

## 4 Conclusions and future work

This paper presented an algorithm for systematically discretising CT systems with non-uniform input and/or output time delays, where the delays could be any combination of the four cases: no delays, integer-multiple

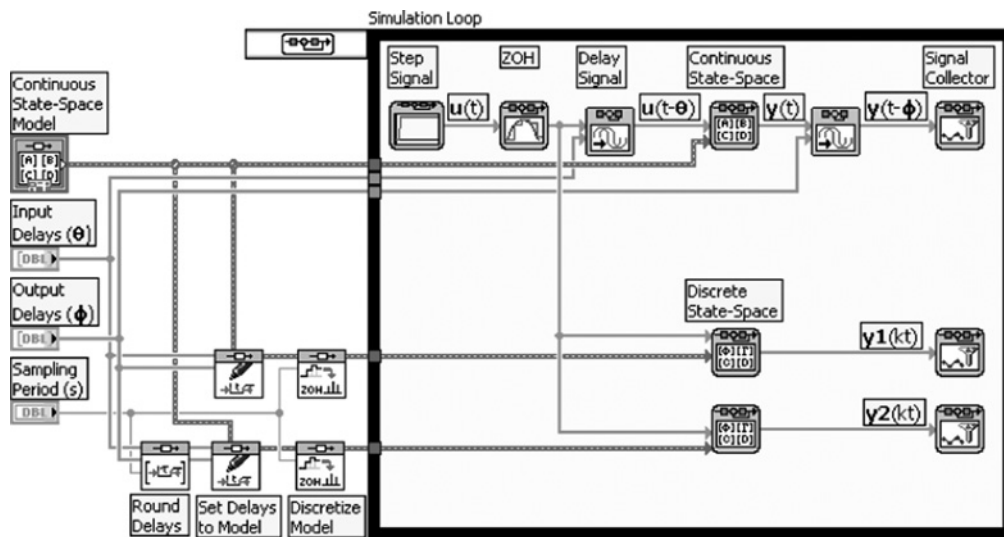

Fig. 7 Simulation of delayed CT SS and its DT equivalent

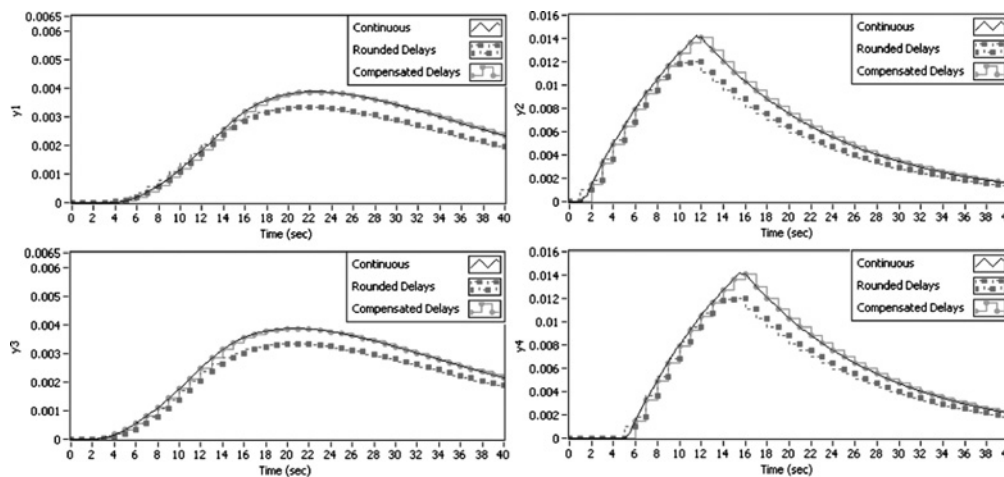

Fig. 8 Response of CT system and its DT equivalents: rounding the delays and compensating for the delays

Table 2 Relative percentage errors along the simulation time

ZOH method	$\epsilon_1, \%$	$\epsilon_2, \%$	$\epsilon_3, \%$	$\epsilon_4, \%$
delay compensation	0.0	0.0	0.0	0.0
delay rounding	19.1	15.6	21.6	15.8

delays, fractional delays and integer-multiple plus fractional delays. In particular, this algorithm is capable of handling all  $2^8$  possible cases of CT LTI systems with input and/or output delays. This algorithm was applied to discretise a fourth-order MIMO heat exchanger process with four inputs and four outputs, where each input and output signal experienced one of the four different delay cases. Moreover, this MIMO system was discretised by rounding the input and output delays to the closest integer-multiple of the sampling time. The two resulting DT models were simulated and compared against the CT model. It was noted that the response from the DT system obtained through the proposed algorithm matched its CT counterpart at the sampling instants. However, the response obtained from the DT system obtained through rounding the delays exhibited significant mismatches with the CT response.

Future work would study whether the stability of the DT system is endangered by the additional system modes, especially if the chosen sampling time is large. Since the algorithm presented in this paper derived explicit closed-form expressions for the DT equivalent system matrices, this assessment should not be troublesome. In addition, it is important to analyse the spectrum of the discretised system against its CT counterpart, and study how the additional poles are distributed with respect to the poles of the original CT system.

While the algorithm considered in this paper assumed a fixed sampling rate and ZOH of the inputs, extending such formalism to the multi-rate context apart or combined with extensions to other hold techniques, such as first-order hold (FOH) is a potential future research direction. Moreover, while the derived DT equivalent system was exact, it would be instructive to compare it against a DT equivalent system derived through the Padé approximation method. Such comparison would study the computational complexity associated with each method and the trade-offs between the order of the Padé approximation and the accuracy of the derived DT model.

Finally, the derived discretisation algorithm in this paper can be exploited in designing digital controllers to systems



experiencing different combinations of input and/or output time delays. This might be true even when such delays are uncertain. In this respect, if time-stamping techniques of the inputs and outputs are employed, then the delays may be determined. Consequently, based on the measured time delays, the algorithm presented in this paper can re-discretise 'on-the-fly' the CT dynamics, leading to a DT model, which can be used to design a controller that is robust to the presumed delays in the system.

## 5 Acknowledgments

The author would like to thank Ari Arapostathis and Ricardo Dunia for suggestions that improved this work. The author would like also to thank the reviewers for their constructive suggestions that improved the presentation of this work.

## 6 References

- Guo, S.M., Wang, W., Shieh, L.S.: 'Discretisation of two degree-of-freedom controller and system with state, input and output delays', *IEE Proc. Control Theory Appl.*, 2000, **147**, (1), pp. 87–96
- Sheridan, T.B.: 'Space teleoperation through time delay: review and prognosis', *IEEE Trans. Robot. Autom.*, 1993, **9**, (5), pp. 592–606
- Rattan, K.S.: 'Compensating for computational delay in digital equivalent of continuous control systems', *IEEE Trans. Autom. Control*, 1989, **34**, (8), pp. 895–899
- Wittenmark, B., Nilsson, J., Torngren, M.: 'Timing problems in real-time control systems'. Proc. IEEE American Control Conf., Seattle, Washington, 1995, pp. 2000–2004
- Wen, P., Cao, J., Li, Y.: 'Design of high-performance networked real-time control systems', *IET Proc. Control Theory Appl.*, 2007, **1**, (5), pp. 1329–1335
- Yang, T.C., Peng, C., Yue, D., Fei, M.R.: 'New study of controller design for networked control systems', *IET Proc. Control Theory Appl.*, 2010, **4**, (7), pp. 1109–1121
- Normey-Rico, J.E., Camacho, E.F.: 'Control of dead-time processes' (Springer, London, 2007)
- Ou, L., Zhang, W., Gu, D.: 'Sets of stabilising PID controllers for second-order integrating processes with time delay', *IEE Proc. Control Theory Appl.*, 2006, **153**, (5), pp. 607–614
- Hwang, C., Hwang, J.H.: 'Stabilisation of first-order plus dead-time unstable processes using PID controllers', *IEE Proc. Control Theory Appl.*, 2004, **151**, (1), pp. 89–94
- Moelja, A.A., Meinsma, G., Kuipers, J.: 'On  $H_2$  control of systems with multiple I/O delays', *IEEE Trans. Autom. Control*, 2006, **51**, (8), pp. 1347–1354
- Park, J.H., Yoo, H.W., Han, S., Kwon, W.H.: 'Receding horizon controls for input-delayed systems', *IEEE Trans. Autom. Control*, 2008, **53**, (7), pp. 1746–1752
- Xia, Y., Shi, P., Liu, G.P., Rees, D., Han, J.: 'Active disturbance rejection control for uncertain multivariable systems with time-delay', *IET Proc. Control Theory Appl.*, 2007, **1**, (1), pp. 75–81
- Richard, J.P.: 'Time-delay systems: an overview of some recent advances and open problems', *Automatica*, 2003, **39**, (10), pp. 1667–1694
- Barcena, R., Etxebarria, A.: 'Mitigating the effect of fractional time delays in hybrid control systems', *IET Proc. Control Theory Appl.*, 2008, **2**, (1), pp. 24–31
- Silva, E.I., Salgado, M.E.: 'Performance bounds for feedback control of non-minimum phase MIMO systems with arbitrary delay structure', *IEE Proc. Control Theory Appl.*, 2005, **152**, (2), pp. 211–219
- Wittenmark, B.: 'Sampling of a system with a time delay', *IEEE Trans. Autom. Control*, 1985, **30**, (5), pp. 507–510
- Fridman, E., Seuret, A., Richard, J.P.: 'Robust sampled-data stabilization of linear systems: an input delay approach', *Automatica*, 2004, **40**, (8), pp. 1441–1446
- Kim, D.W., Park, J.B., Joo, Y.H.: 'Robust stabilisation of sampled-data control systems with non-linear perturbations via digital redesign', *IET Proc. Control Theory Appl.*, 2009, **3**, (8), pp. 1070–1080
- Franklin, G.F., Powell, J.D., Workman, M.: 'Digital control of dynamic systems' (Addison-Wesley, California, 1997, 3rd edn.)
- Astrom, K., Wittenmark, B.: 'Computer-controlled systems' (Prentice-Hall, New Jersey, 1997, 3rd edn.)
- Chen, T., Francis, B.: 'Optimal sampled-data control systems' (Springer, London, Great Britain, 1995)
- Hammarstrom, L., Gros, K.: 'Adaptation of optimal control theory to systems with time delays', *Int. J. Control*, 1980, **32**, (2), pp. 329–357
- Jugo, J.: 'Discretization of continuous time-delay systems'. 15th IFAC Triennial World Congress, Barcelona, Spain, 2002, vol. 15, pp. 117–122
- Zeng, L., Hu, G.D.: 'Discretization of continuous-time systems with input delays', *Acta Automatica Sinica*, 2010, **36**, (10), pp. 1426–1431
- Jury, E.I.: 'Theory and application of the z-transform method' (Wiley, New York, 1964)
- Ogata, K.: 'Discrete-time control systems' (Prentice-Hall, Englewood Cliffs, NJ, 1987)
- Kuznetsov, A.G., Clarke, D.W.: 'Simple numerical algorithms for continuous-to-discrete and discrete-to-continuous conversion of the systems with time delays'. Tenth IFAC Symp. on System Identification (Sysid'94), Copenhagen, Denmark, July 1994, vol. 3, pp. 633–638
- Bernhardsson, B.: 'Sampling of state space systems with several time delays'. Preprints IFAC 12th World Congress'93, Sydney, Australia, 1993, pp. 361–364
- De la Sen, M., Luo, N.: 'Discretization and FIR filtering of continuous linear systems with internal and external point delays', *Int. J. Control*, 1994, **6**, (2), pp. 1223–1246
- Kassas, Z.M., Dunia, R.: 'Discretization of MIMO systems with nonuniform input and output fractional time delays'. IEEE 45th Conf. on Decision and Control, San Diego, California, December 2006, pp. 2541–2546
- Nilsson, J., Bernhardsson, B., Wittenmark, B.: 'Stochastic analysis and control of real-time systems with random time delays', *Automatica*, 1998, **34**, (1), pp. 57–64
- Nilsson, J., Bernhardsson, B., Wittenmark, B.: 'Stochastic analysis and control of real-time systems with random time delays'. 13th IFAC World Congress, San Francisco, California, 1996, pp. 267–272

## 7 Appendix

### 7.1 Discrete-equivalent system matrices for systems with input delays

$$\Sigma_{R_2} = [\Sigma_{R_2, r_1+1} \quad \Sigma_{R_2, r_1+2} \quad \cdots \quad \Sigma_{R_2, r_2}]$$

$$\Sigma_{R_2, j} = [\psi_j(T) \quad \mathbf{0} \quad \cdots \quad \mathbf{0}], \quad j \in \mathcal{J}_{R_2}$$

$$\Sigma_{R_3} = [\lambda_{r_2+1}(p_{r_2+1}T) \quad \cdots \quad \lambda_{r_3}(p_{r_3}T)]$$

$$\Sigma_{R_4} = [\Sigma_{R_4, r_3+1} \quad \Sigma_{R_4, r_3+2} \quad \cdots \quad \Sigma_{R_4, r_4}]$$

$$\Sigma_{R_4, j} = [\lambda_j(p_j T) \quad \psi_j(p_j T) \quad \mathbf{0} \quad \cdots \quad \mathbf{0}], \quad j \in \mathcal{J}_{R_4}$$

$$\Omega_{R_3} = [\psi_{r_2+1}(p_{r_2+1}T) \quad \cdots \quad \psi_{r_3}(p_{r_3}T)]$$

$$\mathbf{J}_{R_2} = \text{diag}[\mathbf{J}_{R_2, r_1+1} \quad \mathbf{J}_{R_2, r_1+2} \quad \cdots \quad \mathbf{J}_{R_2, r_2}]$$

$$\mathbf{J}_{R_4} = \text{diag}[\mathbf{J}_{R_4, r_3+1} \quad \mathbf{J}_{R_4, r_3+2} \quad \cdots \quad \mathbf{J}_{R_4, r_4}]$$

$$\mathbf{J}_{R_2, j} = \begin{bmatrix} \mathbf{0} & \mathbf{I} \\ \mathbf{0}^T & \mathbf{0}^T \end{bmatrix}, \quad \Psi_{R_1} = [\psi_1(T) \quad \cdots \quad \psi_{r_1}(T)]$$

$$\mathbf{E}_{R_2} = \begin{bmatrix} \mathbf{E}_{R_2, r_1+1, 1} \\ \vdots \\ \mathbf{E}_{R_2, r_2, R_2} \end{bmatrix}, \quad \mathbf{E}_{R_4} = \begin{bmatrix} \mathbf{E}_{R_4, r_3+1, 1} \\ \vdots \\ \mathbf{E}_{R_4, r_4, R_4} \end{bmatrix}$$

$$\mathbf{E}_{R_2, j, f} = \begin{bmatrix} \mathbf{0} \\ \mathbf{e}_f^T \end{bmatrix}, \quad \mathbf{F}_{R_2} = [\mathbf{F}_{R_2, r_1+1} \quad \cdots \quad \mathbf{F}_{R_2, r_2}]$$

$$\mathbf{F}_{R_4} = [\mathbf{F}_{R_4, r_3+1} \quad \cdots \quad \mathbf{F}_{R_4, r_4}], \quad \mathbf{F}_{R_2, j} = [\mathbf{d}_j \quad \mathbf{0} \quad \cdots \quad \mathbf{0}]$$

$$\mathbf{D}_{R_1} = [\mathbf{d}_1 \quad \cdots \quad \mathbf{d}_{r_1}], \quad \mathbf{D}_{R_3} = [\mathbf{d}_{r_2+1} \quad \cdots \quad \mathbf{d}_{r_3}]$$

where  $\{z = 2, j \in \mathcal{J}_{R_2}, f \in \mathcal{F}_{R_2} \triangleq \{1, 2, \dots, R_2\}\}$ ,  $\{z = 4, j \in \mathcal{J}_{R_4}, f \in \mathcal{F}_{R_4} \triangleq \{1, 2, \dots, R_4\}\}$ , and  $\mathbf{e}_f^T$  is standard basis vector consisting of a 1 at the  $f$ th component and 0's everywhere else.

7.2 Discrete-equivalent system matrices for systems with output delays

$$\Lambda_{M_2} = \begin{bmatrix} \Lambda_{M_2,m_1+1} \\ \vdots \\ \Lambda_{M_2,m_2} \end{bmatrix}, \quad \Lambda_{M_2,i} = \begin{bmatrix} \mathbf{c}_i^T \\ \mathbf{0} \end{bmatrix}, \quad i \in \mathcal{I}_{M_2}$$

$$\Lambda_{M_3} = \begin{bmatrix} \mathbf{c}_{m_2+1}^T \Phi(q_{m_2+1}T) \\ \vdots \\ \mathbf{c}_{m_3}^T \Phi(q_{m_3}T) \end{bmatrix}$$

$$\Lambda_{M_4} = \begin{bmatrix} \Lambda_{M_4,m_3+1} \\ \vdots \\ \Lambda_{M_4,m_4} \end{bmatrix}, \quad \Lambda_{M_4,i} = \begin{bmatrix} \mathbf{c}_i^T \Phi(q_i T) \\ \mathbf{0} \end{bmatrix}, \quad i \in \mathcal{I}_{M_4}$$

$$\mathbf{H}_{M_2} = \text{diag}[\mathbf{H}_{M_2,m_1+1} \quad \mathbf{H}_{M_2,m_1+2} \quad \cdots \quad \mathbf{H}_{M_2,m_2}]$$

$$\mathbf{H}_{M_4} = \text{diag}[\mathbf{H}_{M_4,m_3+1} \quad \mathbf{H}_{M_4,m_3+2} \quad \cdots \quad \mathbf{H}_{M_4,m_4}]$$

$$\mathbf{H}_{M_2,i} = \begin{bmatrix} \mathbf{0}^T & \mathbf{0}^T \\ \mathbf{I} & \mathbf{0} \end{bmatrix}, \quad \mathbf{C}_{M_1} = \begin{bmatrix} \mathbf{c}_1^T \\ \vdots \\ \mathbf{c}_{m_1}^T \end{bmatrix}, \quad \mathbf{D}_{M_1} = \begin{bmatrix} \mathbf{d}_1^T \\ \vdots \\ \mathbf{d}_{m_1}^T \end{bmatrix}$$

$$\mathbf{G}_{M_2} = \text{diag}[\mathbf{g}_{M_2,m_1+1}^T \quad \mathbf{g}_{M_2,m_1+2}^T \quad \cdots \quad \mathbf{g}_{M_2,m_2}^T]$$

$$\mathbf{G}_{M_4} = \text{diag}[\mathbf{g}_{M_4,m_3+1}^T \quad \mathbf{g}_{M_4,m_3+2}^T \quad \cdots \quad \mathbf{g}_{M_4,m_4}^T]$$

$$\mathbf{g}_{M_z,i}^T = [0 \quad \cdots \quad 0 \quad 1], \quad \{z=2, i \in \mathcal{I}_{M_2}\}, \quad \{z=4, i \in \mathcal{I}_{M_4}\}$$

$$\mathbf{Y}_{M_2} = \begin{bmatrix} \mathbf{Y}_{M_2,m_1+1} \\ \vdots \\ \mathbf{Y}_{M_2,m_2} \end{bmatrix}, \quad \mathbf{Y}_{M_2,i} = \begin{bmatrix} \mathbf{d}_i^T \\ \mathbf{0} \end{bmatrix}, \quad i \in \mathcal{I}_{M_2}$$

$$\mathbf{Y}_{M_3} = \begin{bmatrix} \mathbf{c}_{m_2+1}^T \Psi(q_{m_2+1}T) + \mathbf{d}_{m_2+1}^T \\ \vdots \\ \mathbf{c}_{m_3}^T \Psi(q_{m_3}T) + \mathbf{d}_{m_3}^T \end{bmatrix}$$

$$\mathbf{Y}_{M_4} = \begin{bmatrix} \mathbf{Y}_{M_4,m_3+1} \\ \vdots \\ \mathbf{Y}_{M_4,m_4} \end{bmatrix}$$

$$\mathbf{Y}_{M_4,i} = \begin{bmatrix} \mathbf{c}_{m_i}^T \Psi(q_{m_i}T) + \mathbf{d}_{m_i}^T \\ \mathbf{0} \end{bmatrix}, \quad i \in \mathcal{I}_{M_4}$$

7.3 Discrete-equivalent system matrices for systems with input and output delays

$$\mathbf{A}_{d,IO,11} \equiv \mathbf{A}_{d,I}, \quad \mathbf{A}_{d,IO,12} \equiv \mathbf{0}, \quad \mathbf{B}_{d,IO,11} \equiv \mathbf{B}_{d,I}$$

$$\mathbf{A}_{d,IO,12} = \begin{bmatrix} \Lambda_{M_2} & \mathbf{L}_{M_2} & \Xi_{M_2} & \mathbf{N}_{M_2} \\ \Lambda_{M_3} & \mathbf{L}_{M_3} & \Xi_{M_3} & \mathbf{N}_{M_3} \\ \Lambda_{M_4} & \mathbf{L}_{M_4} & \Xi_{M_4} & \mathbf{N}_{M_4} \end{bmatrix}$$

$$\mathbf{A}_{d,IO,22} = \begin{bmatrix} \mathbf{H}_{M_2} & \mathbf{0} & \mathbf{0} \\ \mathbf{0} & \mathbf{0} & \mathbf{0} \\ \mathbf{0} & \mathbf{0} & \mathbf{H}_{M_4} \end{bmatrix}$$

$$\mathbf{B}_{d,IO,21} = \begin{bmatrix} \mathbf{\Pi}_{M_2,R_1} & \mathbf{0} & \mathbf{0} & \mathbf{0} \\ \mathbf{\Pi}_{M_3,R_1} & \mathbf{0} & \mathbf{\Pi}_{M_3,R_3} & \mathbf{0} \\ \mathbf{\Pi}_{M_4,R_1} & \mathbf{0} & \mathbf{\Pi}_{M_4,R_3} & \mathbf{0} \end{bmatrix}$$

$$\mathbf{C}_{d,IO,11} = \begin{bmatrix} \mathbf{C}_{M_1} & \mathbf{F}_{M_1,R_2} & \mathbf{D}_{M_1,R_3} & \mathbf{F}_{M_1,R_4} \\ \mathbf{0} & \mathbf{0} & \mathbf{0} & \mathbf{0} \\ \mathbf{0} & \mathbf{0} & \mathbf{0} & \mathbf{0} \\ \mathbf{0} & \mathbf{0} & \mathbf{0} & \mathbf{0} \end{bmatrix}$$

$$\mathbf{C}_{d,IO,12} = \begin{bmatrix} \mathbf{0} & \mathbf{0} & \mathbf{0} \\ \mathbf{G}_{M_2} & \mathbf{0} & \mathbf{0} \\ \mathbf{0} & \mathbf{I} & \mathbf{0} \\ \mathbf{0} & \mathbf{0} & \mathbf{G}_{M_4} \end{bmatrix}$$

$$\mathbf{D}_{d,IO} = \begin{bmatrix} \mathbf{D}_{M_1,R_1} & \mathbf{0} & \mathbf{0} & \mathbf{0} \\ \mathbf{0} & \mathbf{0} & \mathbf{0} & \mathbf{0} \\ \mathbf{0} & \mathbf{0} & \mathbf{0} & \mathbf{0} \\ \mathbf{0} & \mathbf{0} & \mathbf{0} & \mathbf{0} \end{bmatrix}$$

$$\mathbf{L}_{M_2} = \begin{bmatrix} \mathbf{L}_{M_2,m_1+1,r_1+1} & \cdots & \mathbf{L}_{M_2,m_1+1,r_2} \\ \vdots & \ddots & \vdots \\ \mathbf{L}_{M_2,m_2,r_1+1} & \cdots & \mathbf{L}_{M_2,m_2,r_2} \end{bmatrix}$$

$$\mathbf{L}_{M_2,i,j} = \begin{bmatrix} d_{i,j} & \mathbf{0}^T \\ \mathbf{0} & \mathbf{0} \end{bmatrix}, \quad i \in \mathcal{I}_{M_2}, \quad j \in \mathcal{J}_{R_2}$$

$$\Xi_{M_2} = \begin{bmatrix} \Xi_{M_2,m_1+1} \\ \vdots \\ \Xi_{M_2,m_2} \end{bmatrix}, \quad \Xi_{M_2,i} = \begin{bmatrix} d_{i,r_2+1} & \cdots & d_{i,r_3} \\ \mathbf{0} \end{bmatrix}, \quad i \in \mathcal{I}_{M_2}$$

$$\mathbf{N}_{M_2} = \begin{bmatrix} \mathbf{N}_{M_2,m_1+1,r_3+1} & \cdots & \mathbf{N}_{M_2,m_1+1,r_4} \\ \vdots & \ddots & \vdots \\ \mathbf{N}_{M_2,m_2,r_3+1} & \cdots & \mathbf{N}_{M_2,m_2,r_4} \end{bmatrix}$$

$$\mathbf{N}_{M_2,i,j} = \mathbf{L}_{M_2,i,j} \mathbf{L}_{M_3} = [\mathbf{L}_{M_3,r_1+1} \quad \cdots \quad \mathbf{L}_{M_3,r_2}]$$

$$\mathbf{L}_{M_3,j} = \begin{bmatrix} \mu_{R_2,j,m_2+1} \\ \vdots \\ \mathbf{0} \\ \mu_{R_2,j,m_3} \end{bmatrix}, \quad j \in \mathcal{J}_{R_2}$$

$$\Xi_{M_3} = \begin{bmatrix} \rho_{R_3,r_2+1,m_2+1} & \cdots & \rho_{R_3,r_3,m_2+1} \\ \vdots & \ddots & \vdots \\ \rho_{R_3,r_2+1,m_3} & \cdots & \rho_{R_3,r_3,m_3} \end{bmatrix}$$

$$\mathbf{N}_{M_3} = [\mathbf{N}_{M_3,r_3+1} \quad \mathbf{N}_{M_3,r_3+2} \quad \cdots \quad \mathbf{N}_{M_3,r_4}]$$

$$\begin{aligned}
 \mathbf{N}_{M_3,j} &= \begin{bmatrix} \rho_{R_4,j,m_2+1} & \pi_{R_4,j,m_2+1} \\ \vdots & \vdots \\ \rho_{R_4,j,m_3} & \pi_{R_4,j,m_3} \end{bmatrix}, \quad j \in \mathcal{J}_{R_4} \\
 \mathbf{L}_{M_4} &= \begin{bmatrix} \mathbf{L}_{M_2,m_3+1,r_1+1} & \cdots & \mathbf{L}_{M_2,m_3+1,r_2} \\ \vdots & \ddots & \vdots \\ \mathbf{L}_{M_2,m_4,r_1+1} & \cdots & \mathbf{L}_{M_2,m_4,r_2} \end{bmatrix} \\
 \mathbf{L}_{M_4,i,j} &= \begin{bmatrix} \mu_{R_2,j,i} & \mathbf{0}^T \\ \mathbf{0} & \mathbf{0} \end{bmatrix}, \quad i \in \mathcal{I}_{M_4}, \quad j \in \mathcal{J}_{R_2} \\
 \Xi_{M_4} &= \begin{bmatrix} \Xi_{M_4,m_3+1} \\ \vdots \\ \Xi_{M_4,m_4} \end{bmatrix} \\
 \Xi_{M_4,i} &= \begin{bmatrix} \rho_{R_3,r_2+1,i} & \cdots & \rho_{R_3,r_3,i} \\ \mathbf{0} & & \end{bmatrix}, \quad i \in \mathcal{I}_{M_4} \\
 \mathbf{N}_{M_4} &= \begin{bmatrix} \mathbf{N}_{M_2,m_3+1,r_3+1} & \cdots & \mathbf{N}_{M_2,m_3+1,r_4} \\ \vdots & \ddots & \vdots \\ \mathbf{N}_{M_2,m_4,r_3+1} & \cdots & \mathbf{N}_{M_2,m_4,r_4} \end{bmatrix} \\
 \mathbf{N}_{M_4,i,j} &= \begin{bmatrix} \rho_{R_4,j,i} & \pi_{R_4,j,i} & \mathbf{0}^T \\ \mathbf{0} & & \end{bmatrix}, \quad i \in \mathcal{I}_{M_4}, \quad j \in \mathcal{J}_{R_4} \\
 \mathbf{\Pi}_{M_2,R_1} &= \begin{bmatrix} \mathbf{\Pi}_{M_2,m_1+1,R_1} \\ \vdots \\ \mathbf{\Pi}_{M_2,m_2,R_1} \end{bmatrix}, \quad \mathbf{\Pi}_{M_2,i,R_1} = \begin{bmatrix} d_{i,1} & \cdots & d_{i,r_1} \\ \mathbf{0} & & \end{bmatrix}, \quad i \in \mathcal{I}_{M_2} \\
 \mathbf{\Pi}_{M_3,R_1} &= \begin{bmatrix} \mu_{R_1,1,m_2+1} & \cdots & \mu_{R_1,r_1,m_2+1} \\ \vdots & \ddots & \vdots \\ \mu_{R_1,1,m_3} & \cdots & \mu_{R_1,r_1,m_3} \end{bmatrix} \\
 \mathbf{\Pi}_{M_3,R_3} &= \begin{bmatrix} \pi_{R_3,r_2+1,m_2+1} & \cdots & \pi_{R_3,r_3,m_2+1} \\ \vdots & \ddots & \vdots \\ \pi_{R_3,r_2+1,m_3} & \cdots & \pi_{R_3,r_3,m_3} \end{bmatrix} \\
 \mathbf{\Pi}_{M_4,R_1} &= \begin{bmatrix} \mathbf{\Pi}_{M_4,m_3+1,R_1} \\ \vdots \\ \mathbf{\Pi}_{M_4,m_4,R_1} \end{bmatrix} \\
 \mathbf{\Pi}_{M_4,i,R_1} &= \begin{bmatrix} \mu_{R_1,1,i} & \cdots & \mu_{R_1,r_1,i} \\ \mathbf{0} & & \end{bmatrix}, \quad i \in \mathcal{I}_{M_4} \\
 \mathbf{\Pi}_{M_4,R_3} &= \begin{bmatrix} \mathbf{\Pi}_{M_4,m_3+1,R_3} \\ \vdots \\ \mathbf{\Pi}_{M_4,m_4,R_3} \end{bmatrix} \\
 \mathbf{\Pi}_{M_4,i,R_3} &= \begin{bmatrix} \pi_{R_3,r_2+1,i} & \cdots & \pi_{R_3,r_3,i} \\ \mathbf{0} & & \end{bmatrix}, \quad i \in \mathcal{I}_{M_4} \\
 \mathbf{F}_{M_1,R_2} &= \begin{bmatrix} \mathbf{F}_{M_1,R_2,r_1+1} & \mathbf{F}_{M_1,R_2,r_1+2} & \cdots & \mathbf{F}_{M_1,R_2,r_2} \end{bmatrix} \\
 \mathbf{F}_{M_1,R_4} &= \begin{bmatrix} \mathbf{F}_{M_1,R_4,r_3+1} & \mathbf{F}_{M_1,R_4,r_3+2} & \cdots & \mathbf{F}_{M_1,R_4,r_4} \end{bmatrix} \\
 \mathbf{F}_{M_1,R_2,j} &= \begin{bmatrix} d_{1,j} \\ \vdots \\ \mathbf{0} \\ \vdots \\ d_{m_1,j} \end{bmatrix}, \quad \{z=2, j \in \mathcal{J}_{R_2}\}, \quad \{z=4, j \in \mathcal{J}_{R_4}\} \\
 \mathbf{D}_{M_1,R_1} &= \begin{bmatrix} d_{1,1} & d_{1,2} & \cdots & d_{1,r_1} \\ \vdots & \vdots & \ddots & \vdots \\ d_{m_1,1} & d_{m_1,2} & \cdots & d_{m_1,r_1} \end{bmatrix} \\
 \mathbf{D}_{M_1,R_3} &= \begin{bmatrix} d_{1,r_2+1} & d_{1,r_2+2} & \cdots & d_{1,r_3} \\ \vdots & \vdots & \ddots & \vdots \\ d_{m_1,r_2+1} & d_{m_1,r_2+2} & \cdots & d_{m_1,r_3} \end{bmatrix}
 \end{aligned}$$